

Contents

PVC-U Door Panels

Acacia	Page 2
Alnwick	Page 2
Althorpe	Page 3
Athens	Page 3
Balmoral	Page 4
Berlin	Page 5
Blenheim	Page 5
Bruges	Page 6
Cambridge	Page 6
Canterbury	Page 7
Canton	Page 7
Chatsworth	Page 8
Frankfurt	Page 8
Hamburg	Page 9
Harewood	Page 9
Highgrove	Page 10
Kensington	Page 10
Lyon	Page 11
Madrid	Page 11
Malaga	Page 12
Milan	Page 12
Modern	Page 13 - 14
Munich	Page 14
Oval	Page 15
Oxford	Page 15
Reims	Page 16
Richmond	Page 16
Rockingham	Page 17
Rome	Page 17
Sandringham	Page 18
Seville	Page 18
Sofia	Page 19
Turin	Page 19
Versailles	Page 20
Vienna	Page 20
Windsor	Page 21

Quarter Panels	Page 21
Conservatory Panels	Page 22 - 23
Half Panels	Page 23
Flat Panels	Page 24

MDF and Thickness Options	Page 24
Ancillaries	Page 25
Backing Glass Options	Page 25
Colour/Woodgrain Options	Page 26
Profile Options	Page 26
Stock Backing Glass	Page 27
Glass Sizes	Page 28
Notes	Page 29
Terms & Conditions	Page 30

Acacia Door Panels

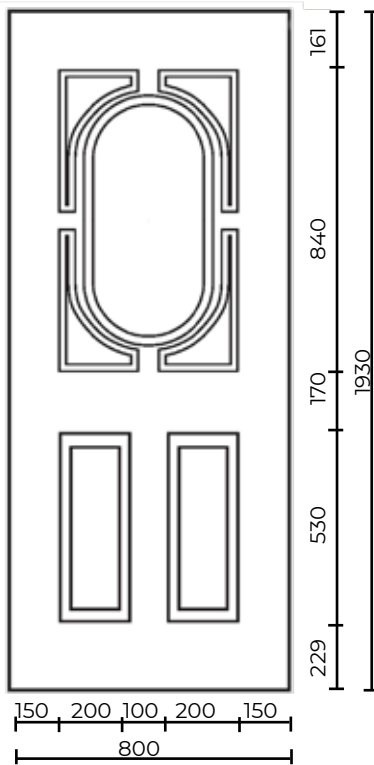

Minimum Cut Size
550mm x 1590mm

Acacia Solid Inverted
Acacia One Inverted

Alnwick Door Panels

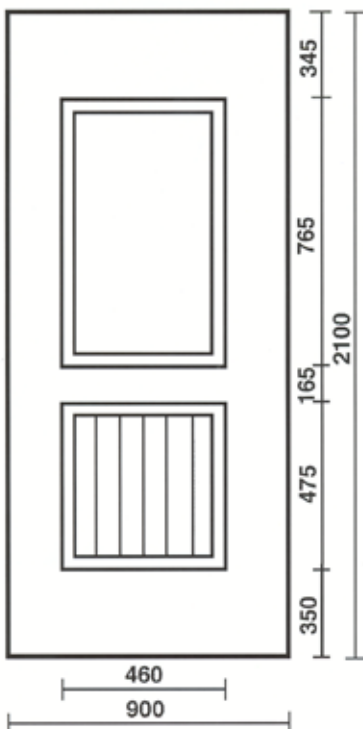

Minimum Cut Size
510mm x 1455mm

Alnwick Solid
Alnwick One
Alnwick One Inverted

Please Note - Not available with solid MDF reinforcing

Althorpe Door Panels

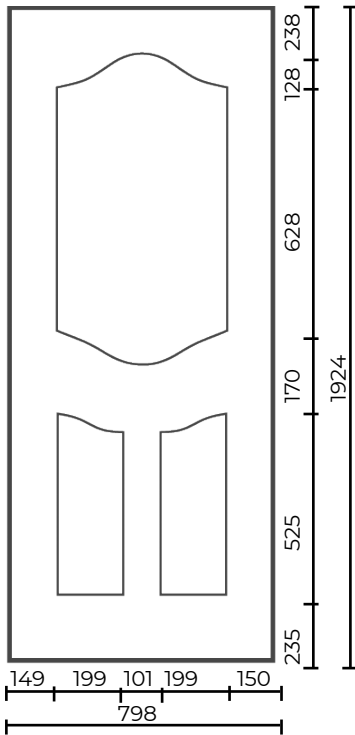

Minimum Cut Size
550mm x 1510mm

Althorpe Solid Oval Inverted
Althorpe One Inverted
Althorpe One Oval Inverted

Please Note - Not available with solid MDF reinforcing

Athens Door Panels

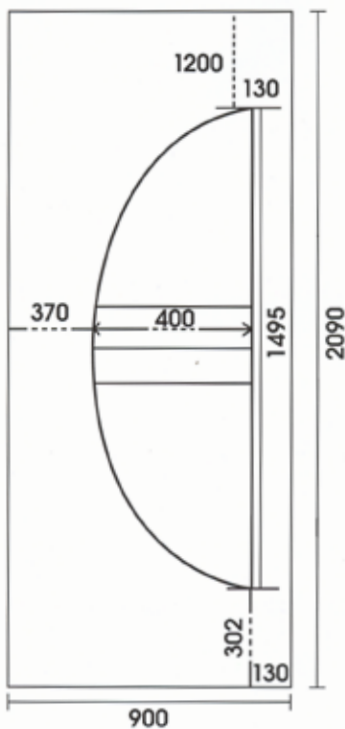

Minimum Cut Size
500mm x 1595mm

Athens Solid
Athens Two

Please note - Glass made up of 2 units

Balmoral Door Panels

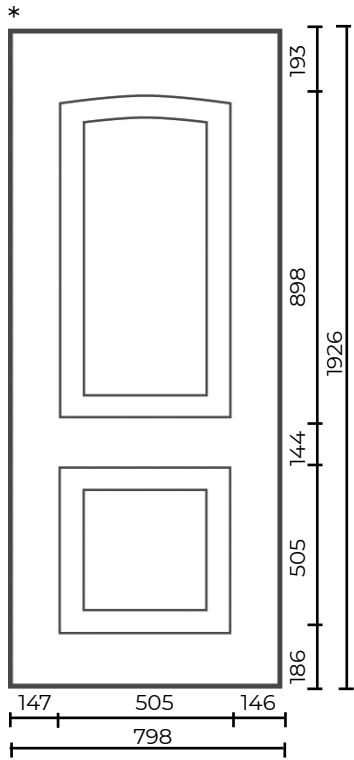

Small Aperture

Minimum Cut Size
550mm x 1595mm

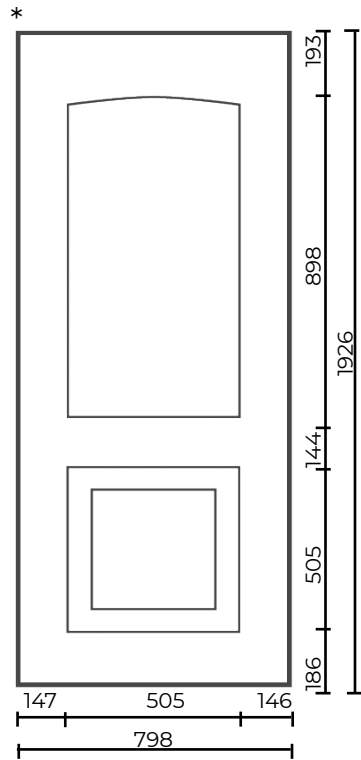

Large Aperture
(Classic)

Minimum Cut Size
550mm x 1595mm

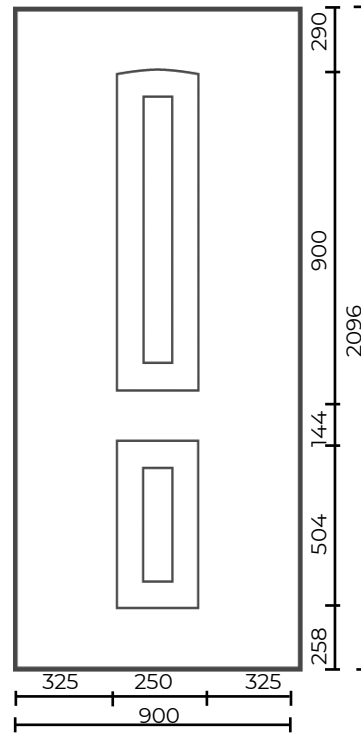

Side

Minimum Cut Size
300mm x 1595mm

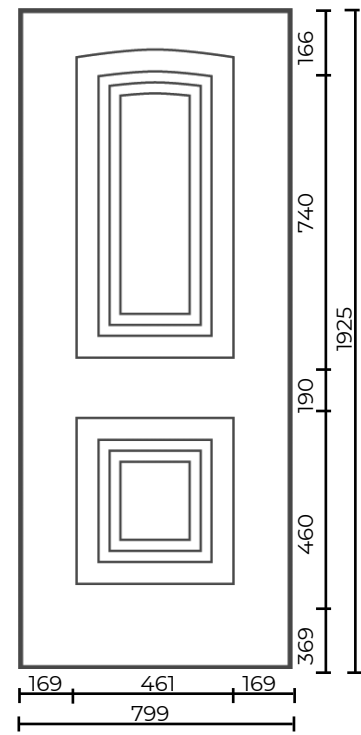

Slimline (Wenland)

Minimum Cut Size
510mm x 1435mm

*Available in Euro Size (900 x 2100)

Balmoral Solid
Balmoral One Small
Balmoral One Classic
Balmoral Two
Balmoral Two Classic
Balmoral One Slimline
Balmoral Two Slimline
Balmoral Side Solid
Balmoral One Classic Side
Balmoral Two Classic Side

Berlin Door Panels

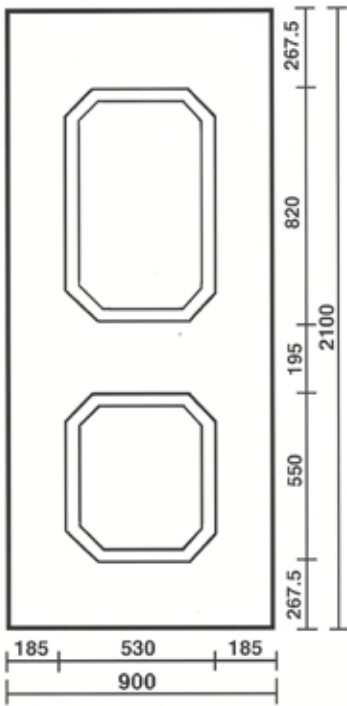

Minimum Cut Size
580mm x 1615mm

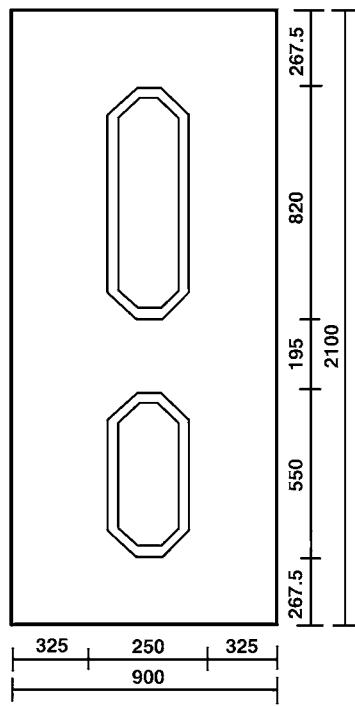

Minimum Cut Size
300mm x 1615mm

Berlin Solid
Berlin One
Berlin Solid Side
Berlin One Side

Blenheim Door Panels

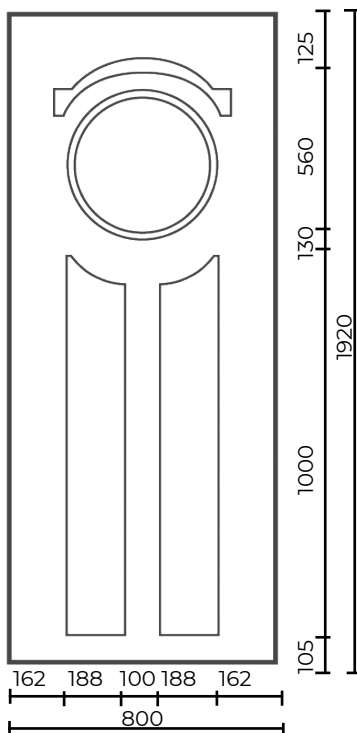

Minimum Cut Size
526mm x 1740mm

Blenheim Solid
Blenheim One

Bruges Door Panels

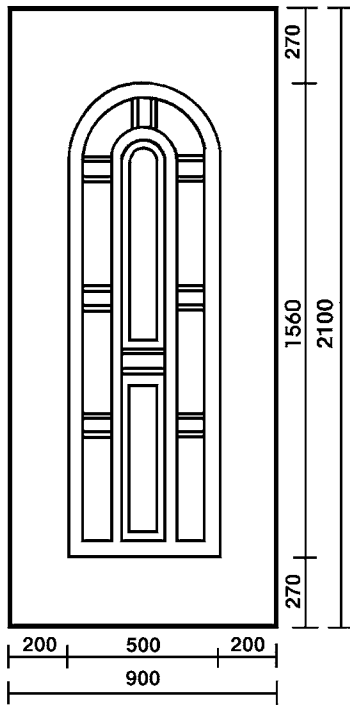

Minimum Cut Size
550mm x 1610mm

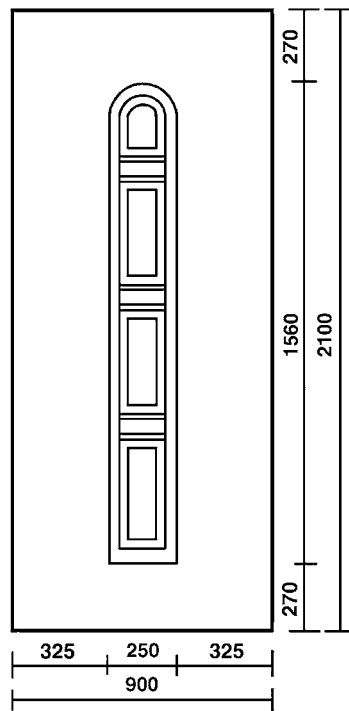

Minimum Cut Size
300mm x 1610mm

Bruges Solid
Bruges Two
Bruges Eight
Bruges Solid Side
Bruges One Side
Bruges Four Side

Cambridge Door Panels

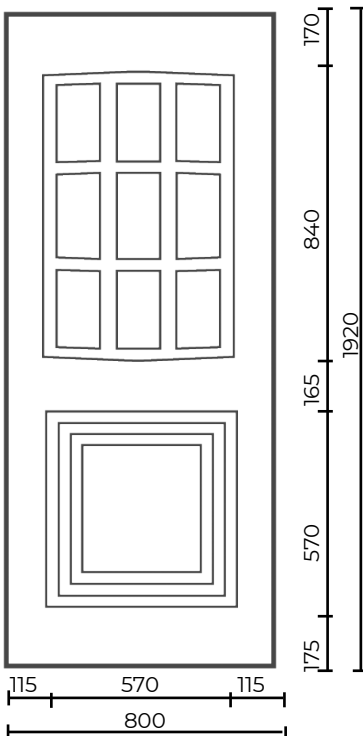

Minimum Cut Size
620mm x 1625mm

Cambridge Georgian Bow Fronted

Please note - One sealed glass unit, not individual pieces
Each rectangle is 110mm x 200mm
Projection - 33mm

Canterbury Door Panels

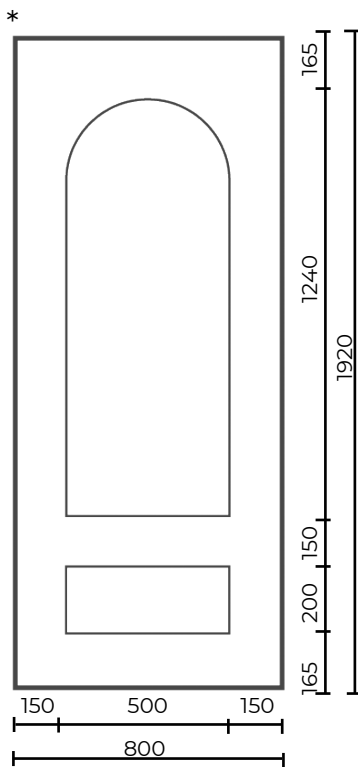

Minimum Cut Size
550mm x 1640mm

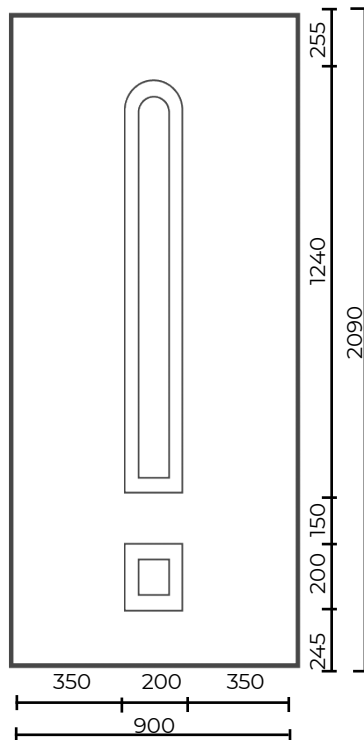

Minimum Cut Size
250mm x 1640mm

Canterbury Solid
Canterbury One
Canterbury Solid Side
Canterbury One Side

*Available in Euro Size (900 x 2100)

Please note - This panel must be reinforced

Canton Door Panels

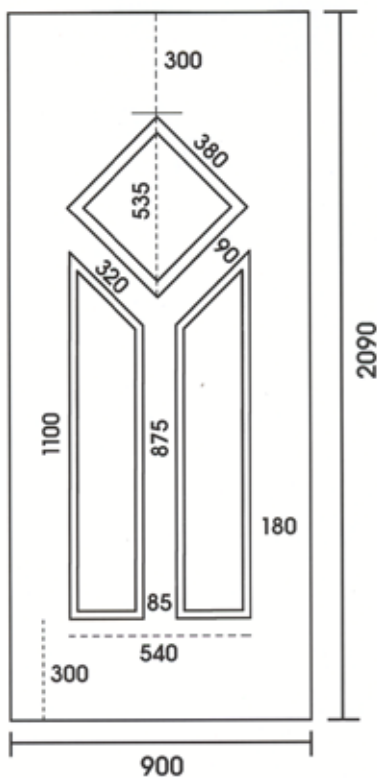

Minimum Cut Size
590mm x 1685mm

Canton Solid
Canton One

Chatsworth Door Panels

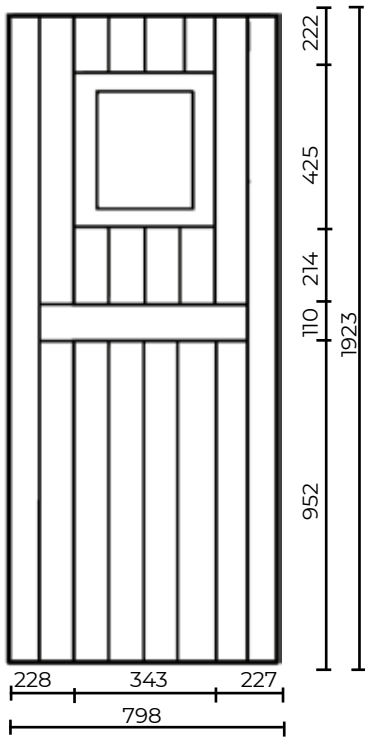

Chatsworth Solid
Chatsworth One

Please Note - This panel is not available with solid MDF reinforcing

Minimum Cut Size
395mm x 805mm

Frankfurt Door Panels

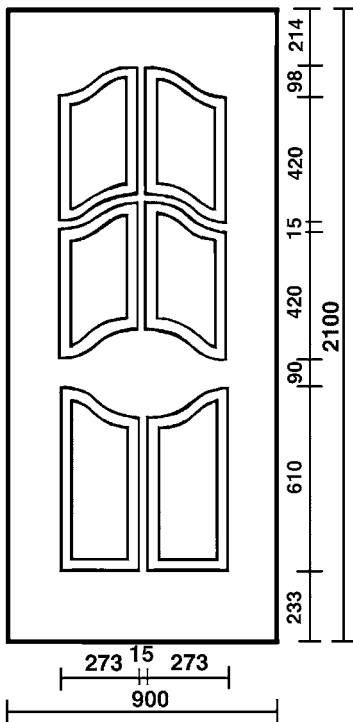

Minimum Cut Size
611mm x 1703mm

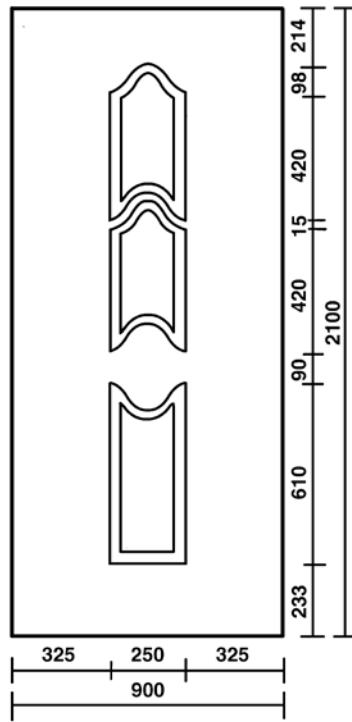

Minimum Cut Size
300mm x 1703

Frankfurt Solid
Frankfurt One
Frankfurt Solid Side
Frankfurt One Side

Hamburg Door Panels

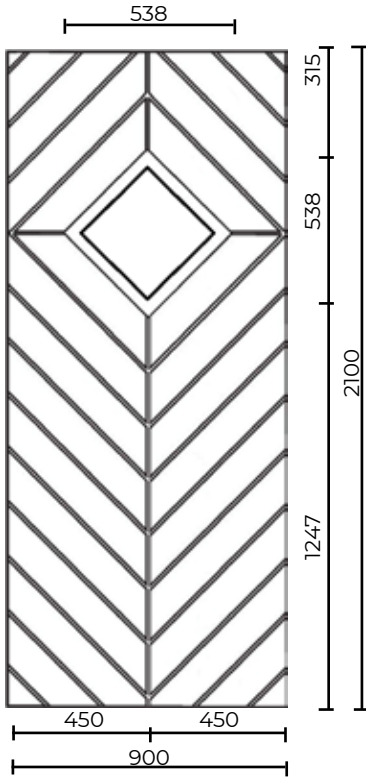

Minimum Cut Size
590mm x 590mm

Hamburg Solid
Hamburg One

Please Note - Not available with solid MDF reinforcing

Harewood Door Panels

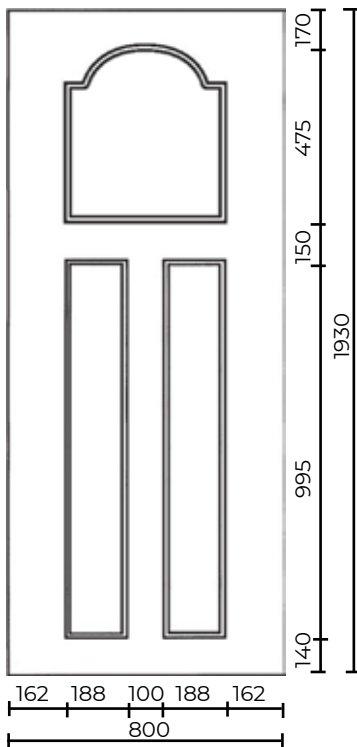

Minimum Cut Size
526mm x 1670mm

Harewood Solid
Harewood One

Highgrove Door Panels

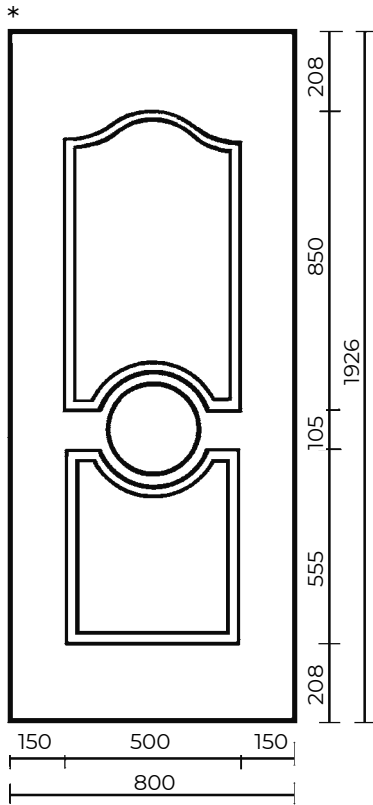

Minimum Cut Size
550mm x 1550mm

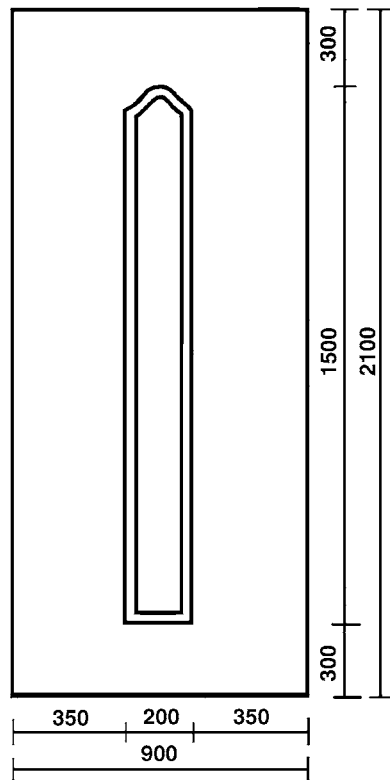

Minimum Cut Size
250mm x 1550mm

Highgrove Solid
Highgrove One
Highgrove Two
Highgrove Solid Side
Highgrove One Side

*Available in Euro Size (900 x 2100)

Kensington Door Panels

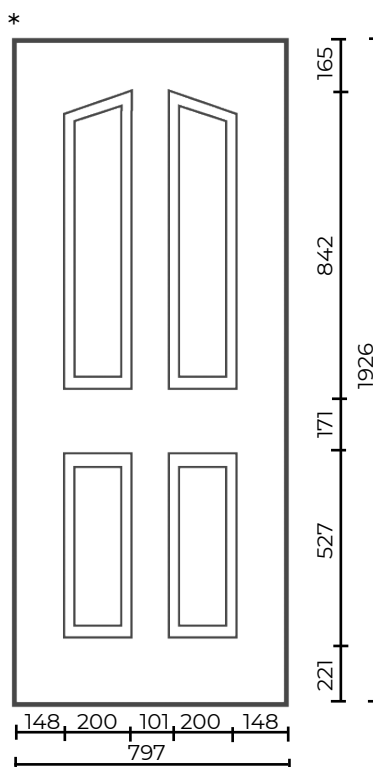

Minimum Cut Size
550mm x 1590mm

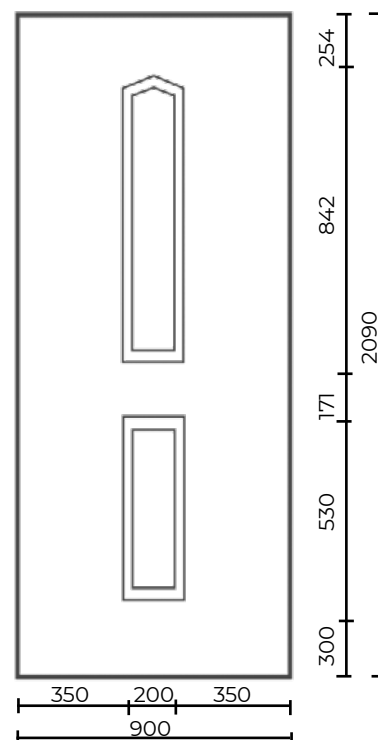

Minimum Cut Size
250mm x 1590mm

Kensington Solid
Kensington Two
Kensington Four
Kensington Solid Side
Kensington One Side
Kensington Two Side

Available inverted except Sides

*Available in Euro Size (900 x 2100)

Lyon Door Panels

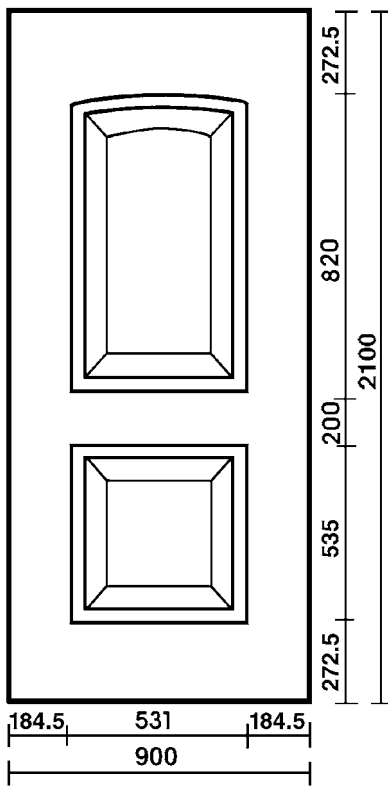

Minimum Cut Size
581mm x 1605mm

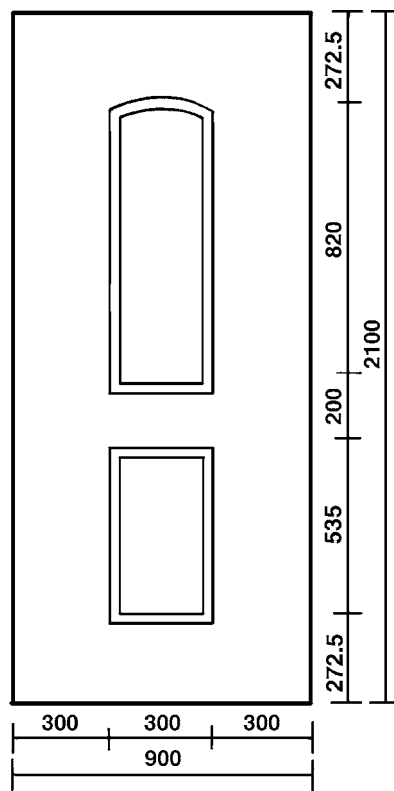

Minimum Cut Size
350mm x 1605mm

Lyon Solid
Lyon One
Lyon Solid Side
Lyon One Side

Madrid Door Panels

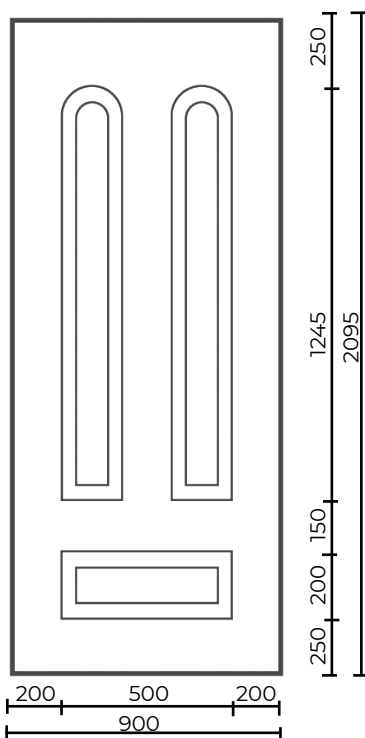

Minimum Cut Size
550mm x 1647mm

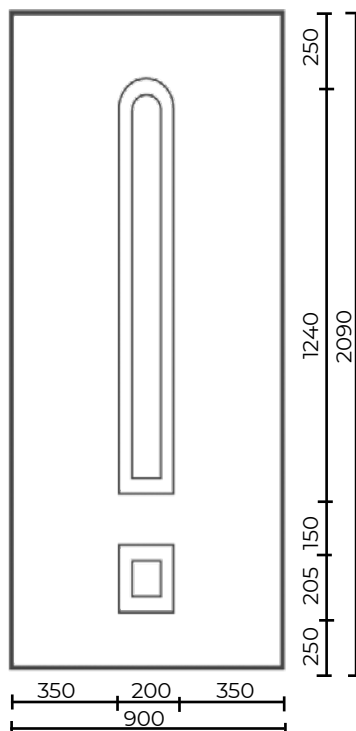

Minimum Cut Size
250mm x 1647mm

Madrid Solid
Madrid Two
Madrid Solid Side
Madrid One Side

Malaga Door Panels

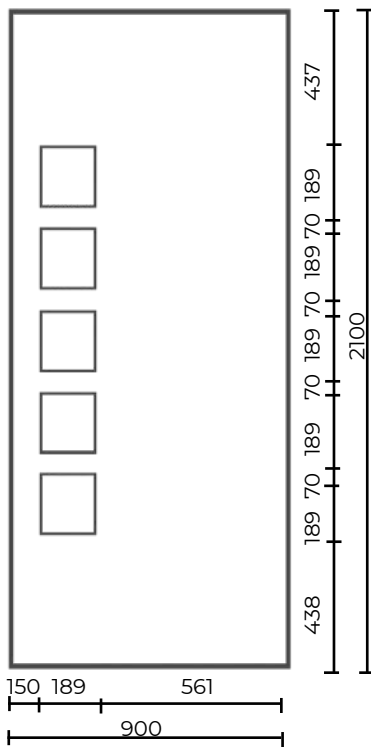

Minimum Cut Size
239mm x 1275mm

Malaga Solid
Malaga Five

Please Note - One piece sealed glass unit not individual pieces

Milan Door Panels

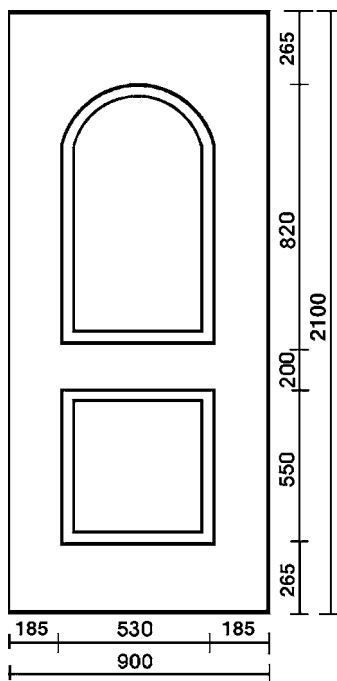

Minimum Cut Size
580mm x 1620mm

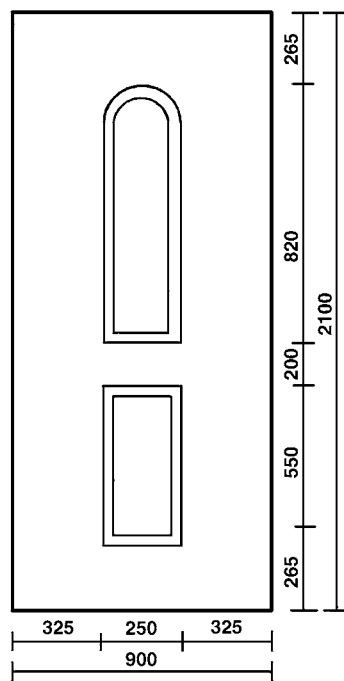

Minimum Cut Size
300mm x 1620mm

Milan Solid
Milan One
Milan Solid Side
Milan One Side

Modern Door Panels

5101

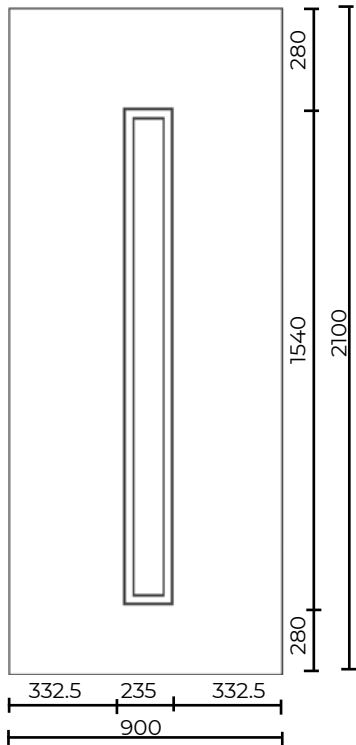

Minimum Cut Size
285mm x 1590mm

5123

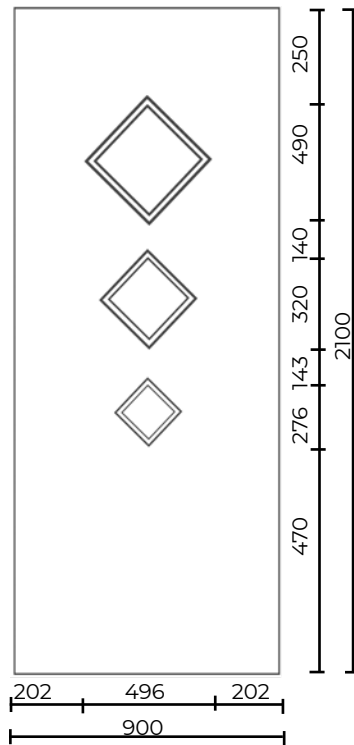

Minimum Cut Size
546mm x 1424mm

5082

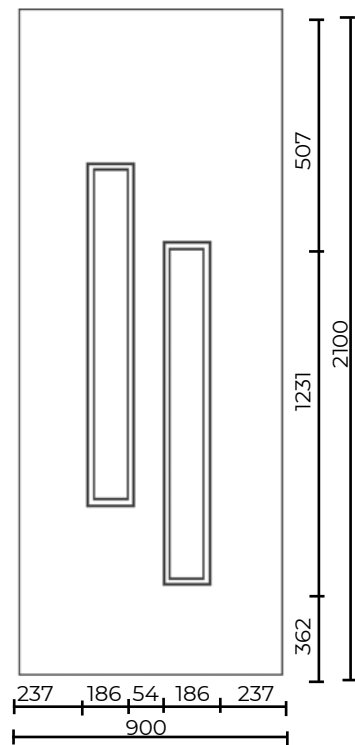

Minimum Cut Size
476mm x 1426mm

5113

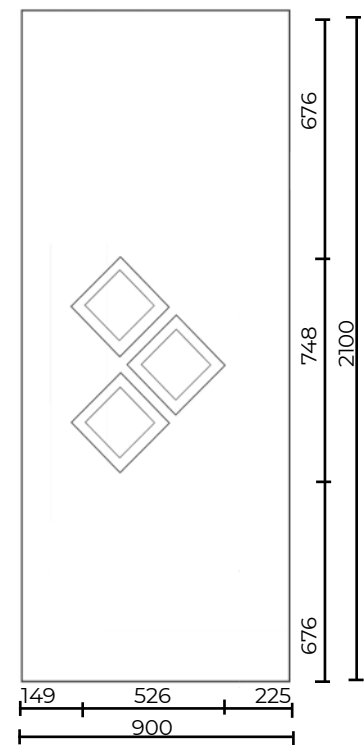

Minimum Cut Size
576mm x 798mm

Modern Door Panels

5013

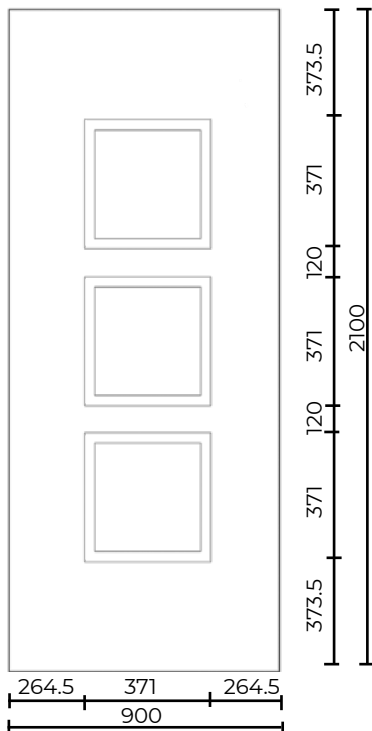

Minimum Cut Size
421mm x 1403mm

5034

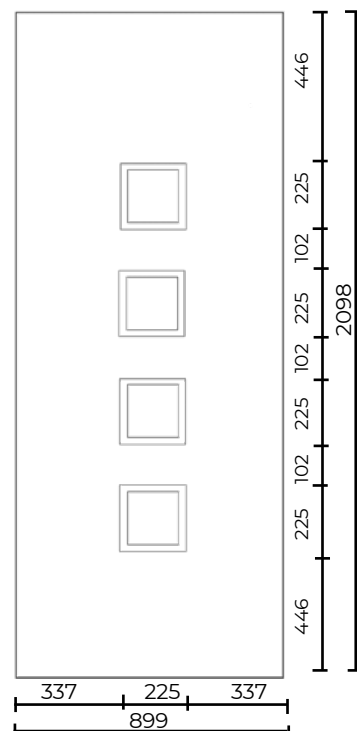

Minimum Cut Size
276mm x 1254mm

5051

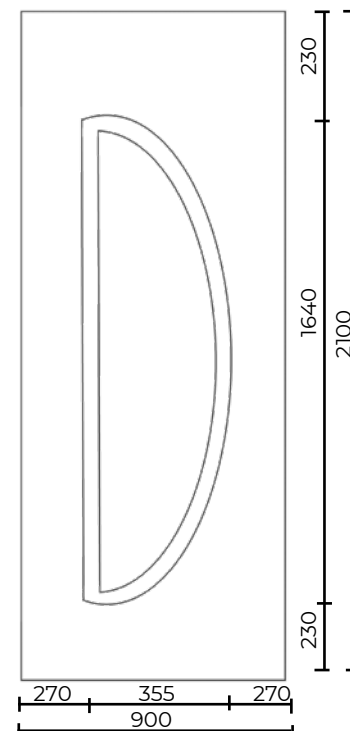

Minimum Cut Size
405mm x 1690mm

5162

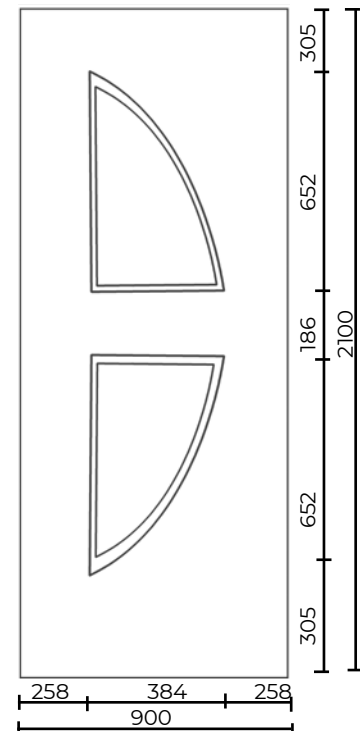

Minimum Cut Size
434mm x 1540mm

Modern Door Panels

5071

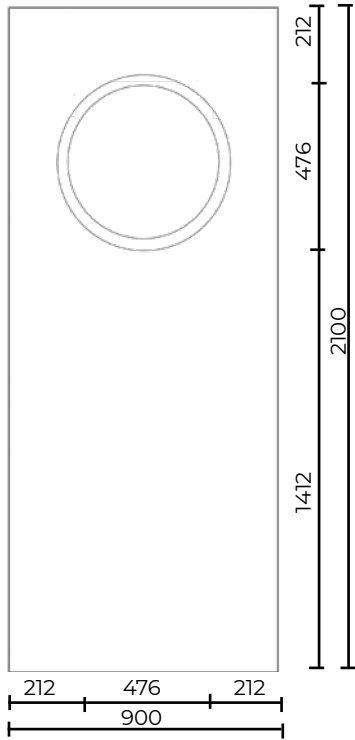

Minimum Cut Size
526mm x 526mm

5131

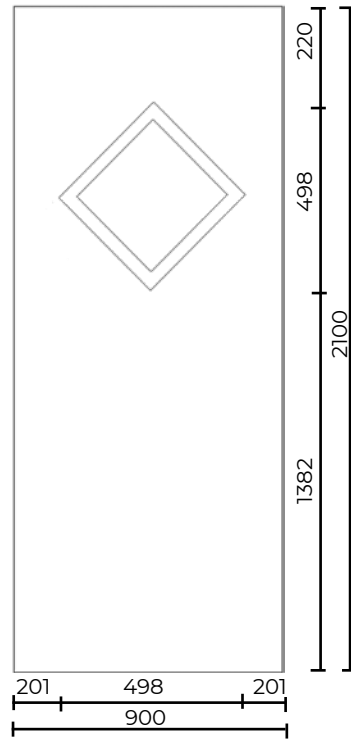

Minimum Cut Size
548mm x 548mm

5141

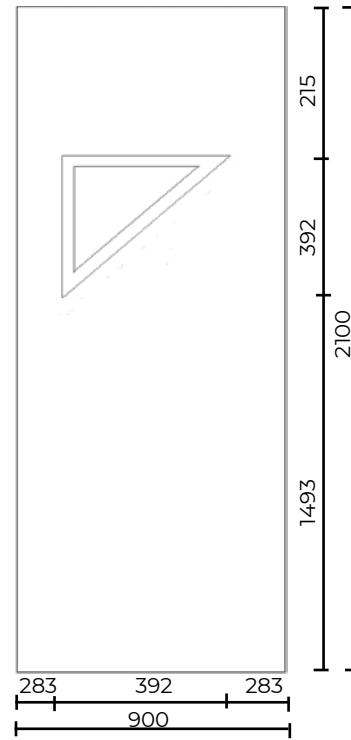

Minimum Cut Size
442mm x 442mm

5171

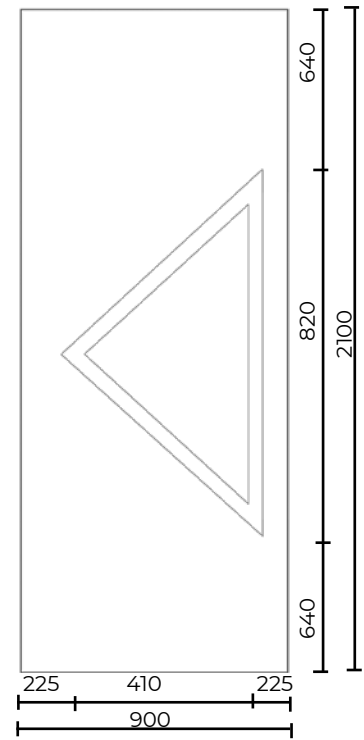

Minimum Cut Size
460mm x 870mm

Please note - Modern Panels Are Not Available Without Trims

Munich Door Panels

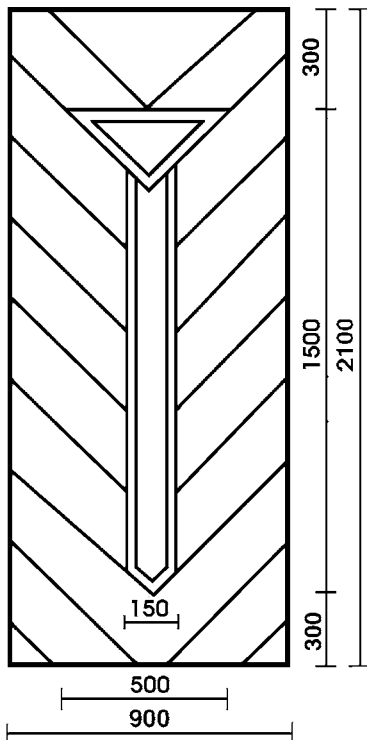

Minimum Cut Size
550mm x 1550mm

Munich Solid
Munich One
Munich Two

Oval Door Panels

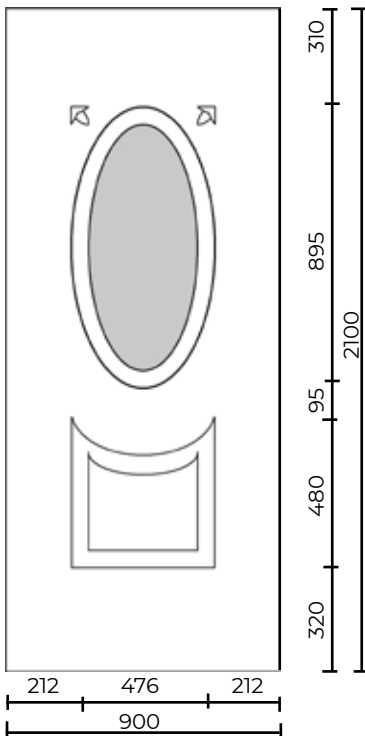

Minimum Cut Size
526mm x 1510mm

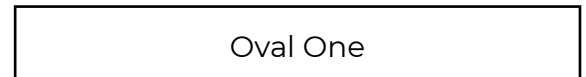

Oxford Door Panels

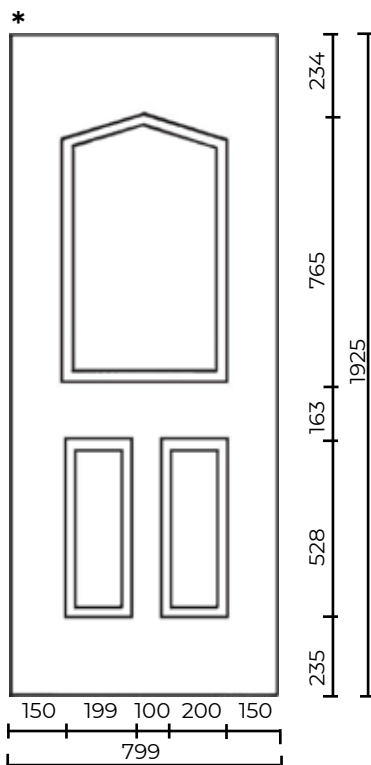

Minimum Cut Size
550mm x 1510mm

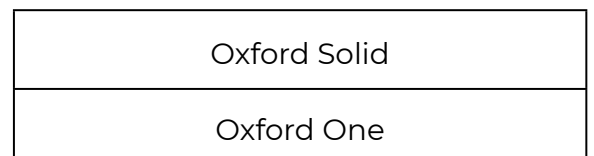

*Available in Euro Size (900 x 2100)

Reims Door Panels

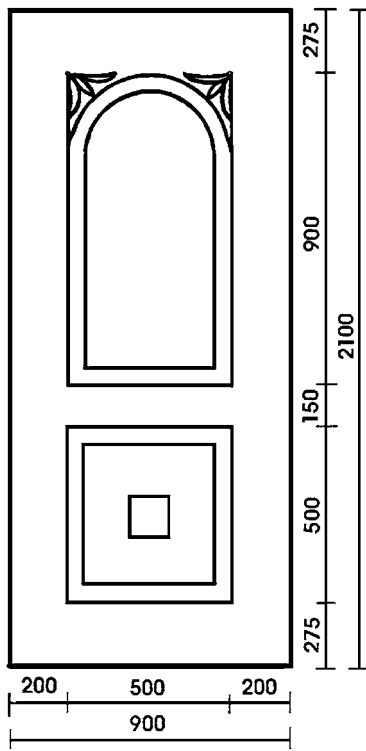

Minimum Cut Size
550mm x 1600mm

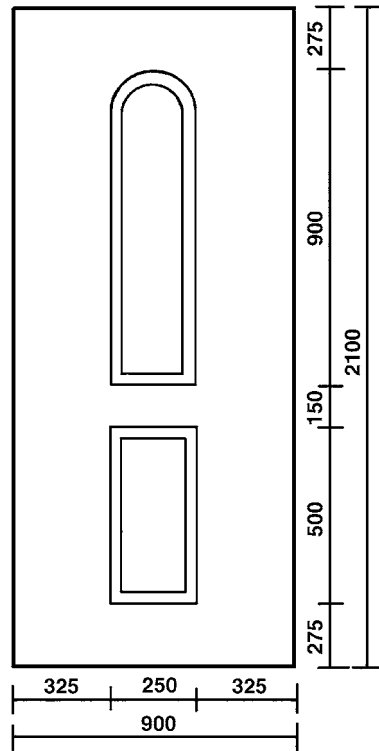

Minimum Cut Size
300mm x 1600mm

Reims Solid
Reims One
Reims Solid Side
Reims One Side

Richmond Door Panels

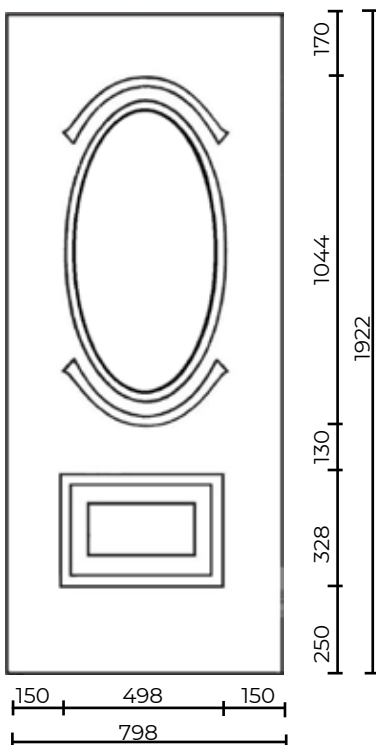

Minimum Cut Size
550mm x 1555mm

Richmond Solid
Richmond One

Rockingham Door Panels

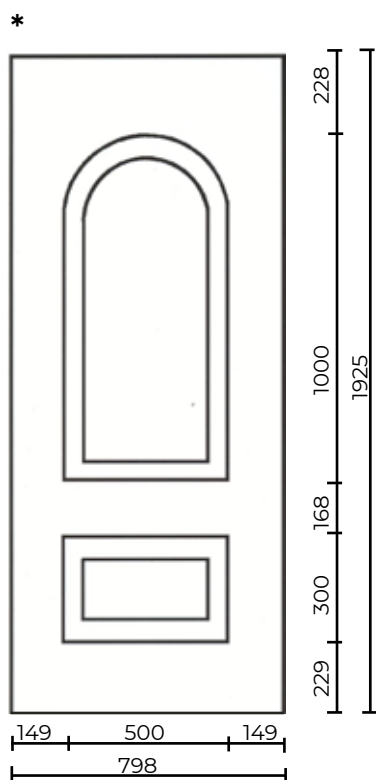

Minimum Cut Size
550mm x 1520mm

Rockingham Solid
Rockingham One

*Available in Euro Size (900 x 2100)

Rome Door Panels

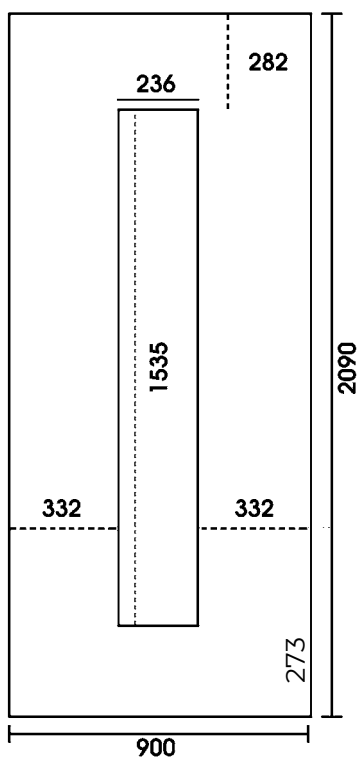

Minimum Cut Size
286mm x 1585mm

Rome Solid
Rome One

Please note - Minimum height to have a letter box - 1700mm

Sandringham Door Panels

*

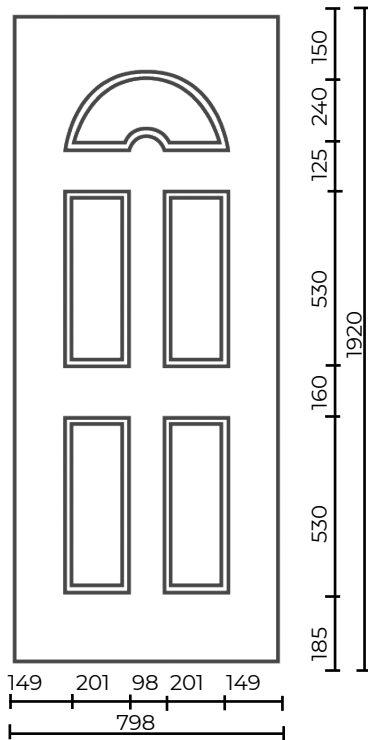

Minimum Cut Size
550mm x 1635mm

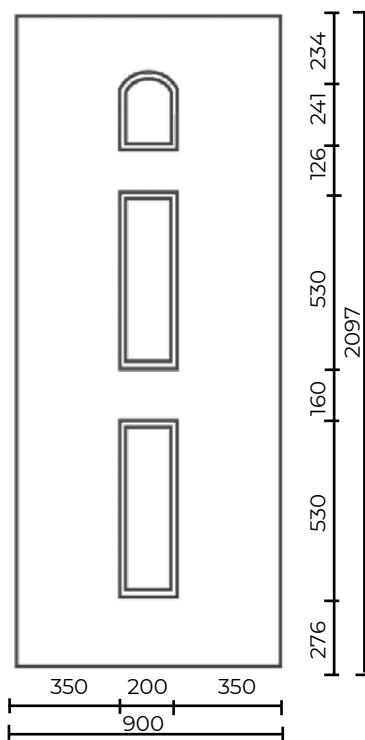

Minimum Cut Size
250mm x 1635mm

Sandringham Solid
Sandringham One
Sandringham Three
Sandringham Five
Sandringham Solid Side
Sandringham One Side
Sandringham Two Side
Sandringham Three Side

*Available in Euro Size (900 x 2100)

Seville Door Panels

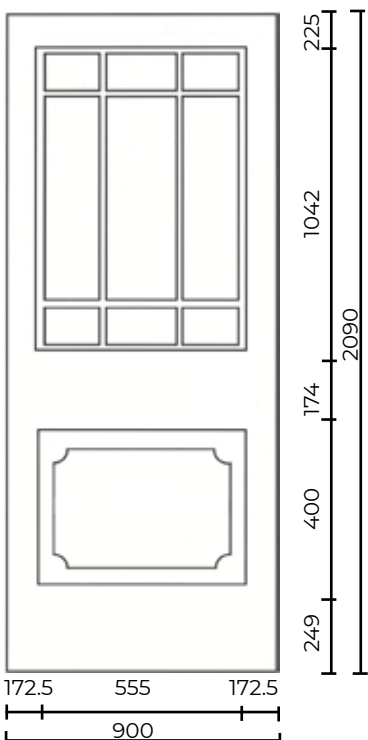

Minimum Cut Size
605mm x 1666mm

Seville Solid
Seville One

Please Note - This panel must be reinforced
- One piece sealed glass unit not individual pieces

Sofia Door Panels

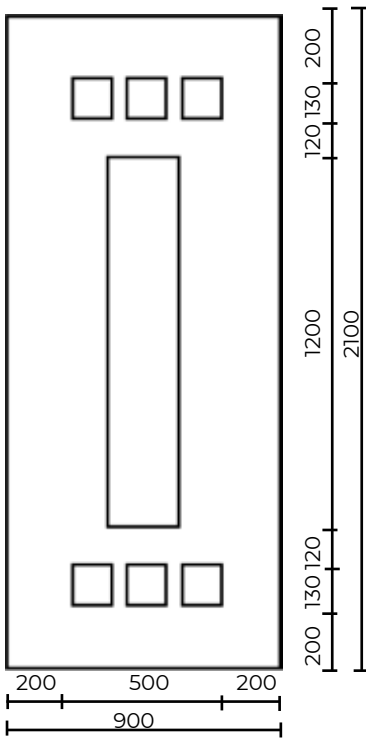

Minimum Cut Size
550mm x 1750mm

Sofia Solid
Sofia One

Turin Door Panels

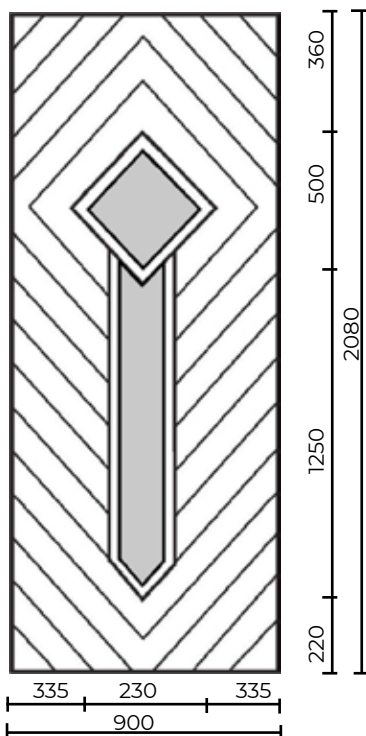

Minimum Cut Size
550mm x 1670mm

Turin Solid
Turin One
Turin Two

Versailles Door Panels

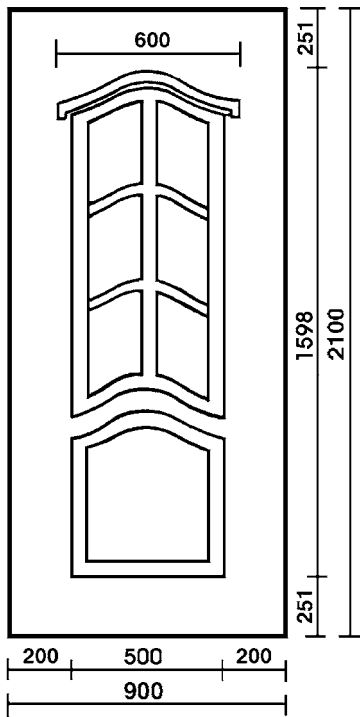

Minimum Cut Size
650mm x 1648mm

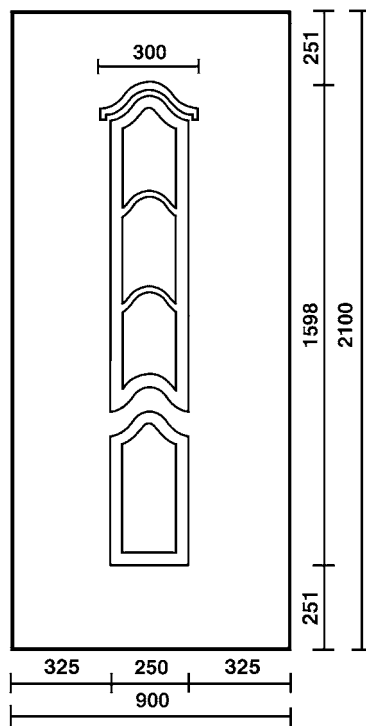

Minimum Cut Size
350mm x 1648mm

Versailles Solid
Versailles One
Versailles Solid Side
Versailles One Side

Vienna Door Panels

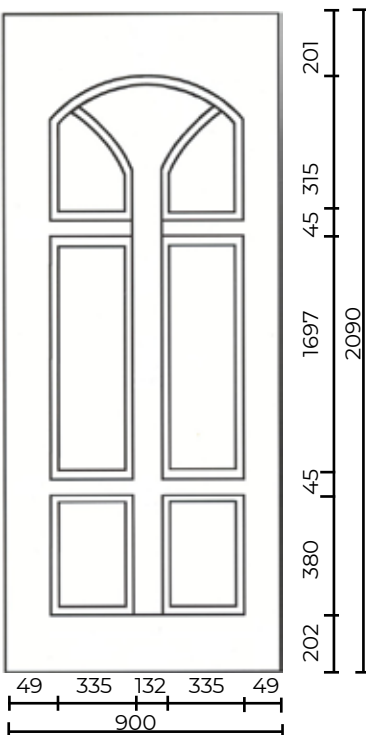

Minimum Cut Size
650mm x 1747mm

Vienna Solid
Vienna Two

Please note - Minimum height available with a letterplate 1825mm

Windsor Door Panels

*

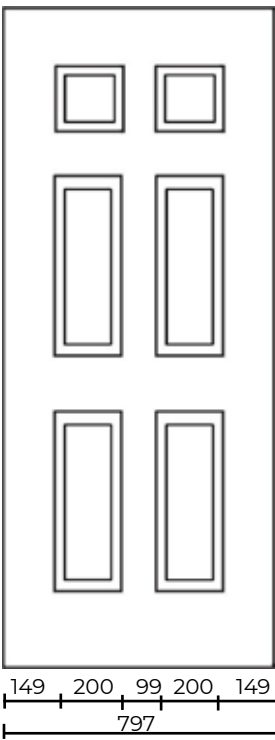

Minimum Cut Size
550mm x 1590mm

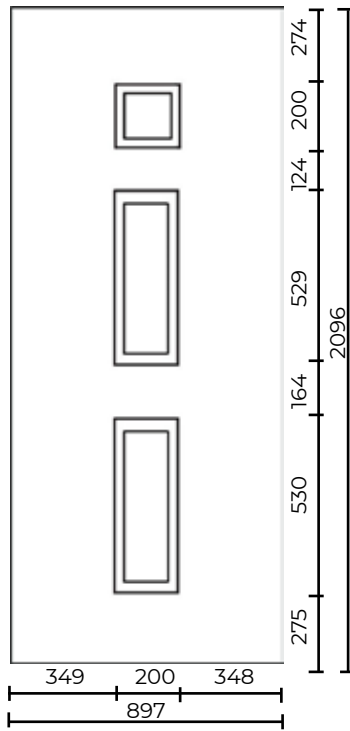

Minimum Cut Size
250mm x 1590mm

Windsor Solid
Windsor Two
Windsor Four
Windsor Six
Windsor Solid Side
Windsor One Side
Windsor Two Side
Windsor Three Side

Available inverted except Sides

*Available in Euro Size (900 x 2100)

Quarter Panels

Elizabethan

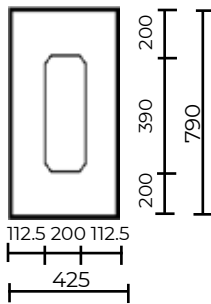

Minimum Cut Size
250mm x 440mm

Winchester

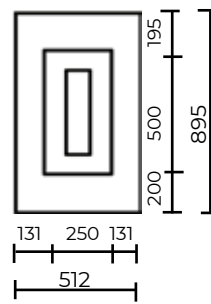

Minimum Cut Size
300mm x 550mm

Manor

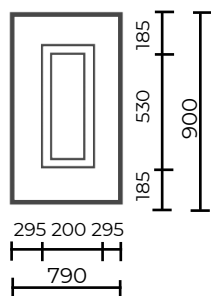

Minimum Cut Size
250mm x 580mm

Cathedral

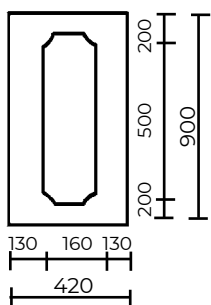

Minimum Cut Size
210mm x 550mm

Conservatory Panels

Hanover

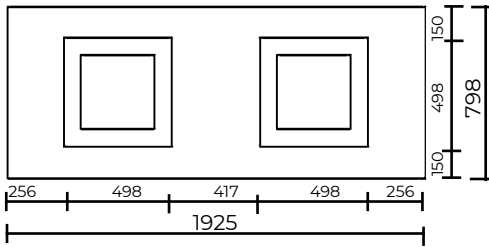

Minimum Cut Size
1470mm x 550mm

Hanover Triple

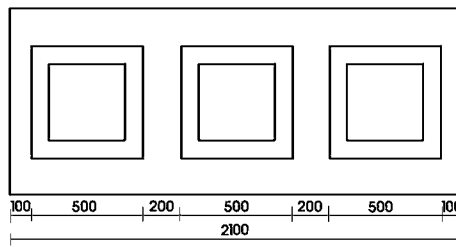

Minimum Cut Size
1950mm x 550mm
Also available with
460mm mould width

Winchester

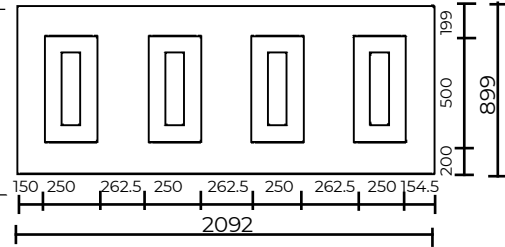

Minimum Cut Size
1845mm x 550mm

Elizabethan

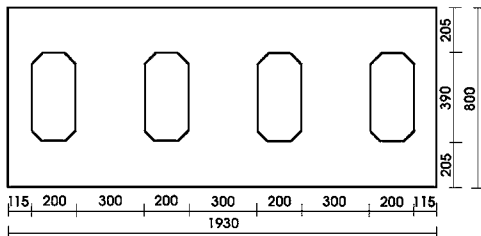

Minimum Cut Size
1750mm x 440mm

Manor

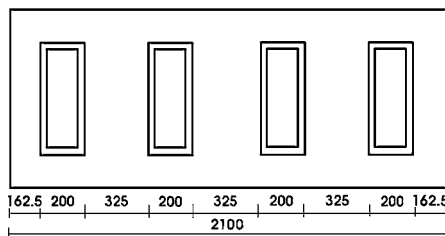

Minimum Cut Size
1825mm x 580mm

Manor Triple

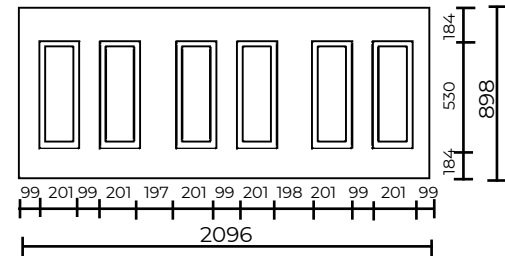

Minimum Cut Size
1950mm x 580mm
Also available with
460mm mould width

Westminster

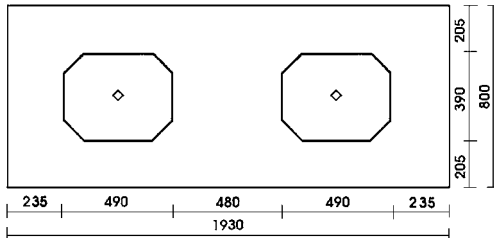

Minimum Cut Size
1510mm x 440mm

Abbey

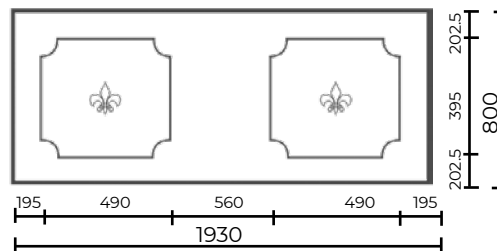

Minimum Cut Size
1590mm x 445mm

Buckingham

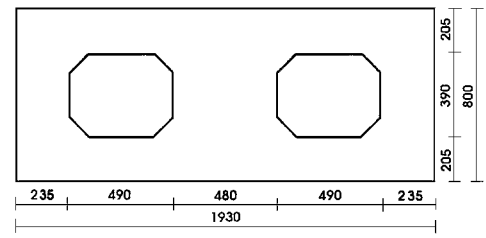

Minimum Cut Size
1510mm x 440mm

Cathedral

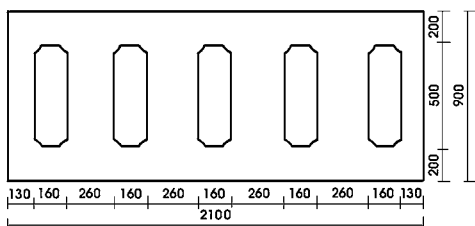

Minimum Cut Size
1890mm x 550mm

Please note - When having
Woodgrain/Colourgrain
the grain runs horizontally
not vertically. These will be
supplied as standard unless
clearly specified otherwise.

Conservatory Panels Continued...

Manor Full

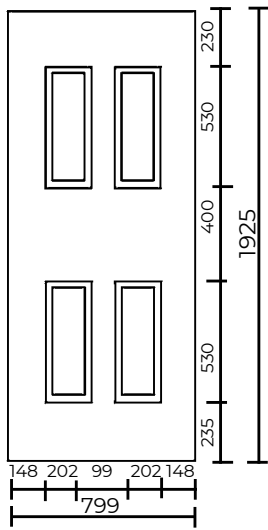

Shiplap

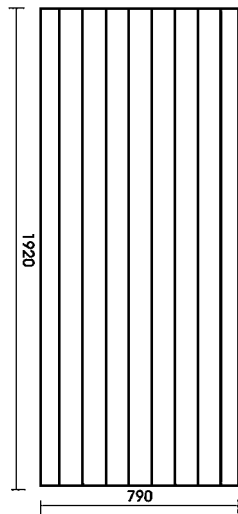

Declap

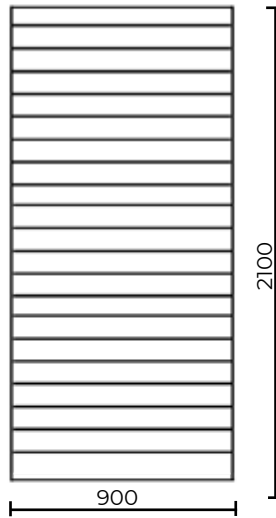

Herringbone

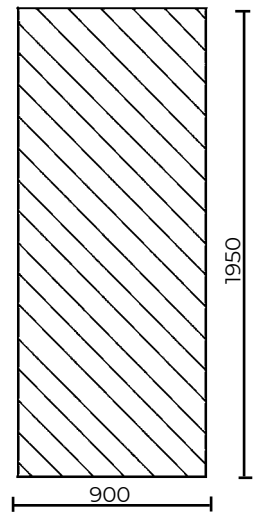

Minimum Cut Size
550mm x 1510

Available Inverted

Also available in Euro size
900mm x 2100mm

**Please Note - the
moulding is slightly
deeper in
Euro sized panels**
Groove size 80mm/10mm

Only available in Euro size
900mm x 2100mm

Groove size 77mm/14mm

Half Panels

Abbey

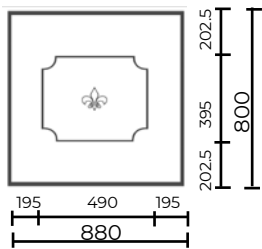

Minimum Cut Size
540mm x 445mm

Buckingham

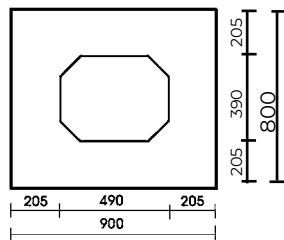

Minimum Cut Size
540mm x 440mm

Manor

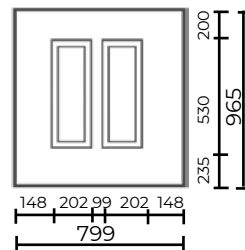

Minimum Cut Size
550mm x 580mm

460mm halves are on a triple half sheet

Manor Inverted

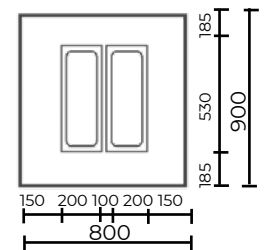

Minimum Cut Size
550mm x 580mm

Hanover

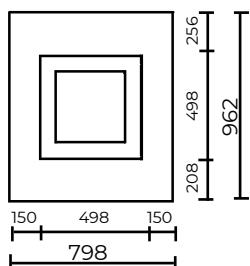

Minimum Cut Size
550mm x 550mm

460mm halves are on a triple half sheet

Hanover Slimline

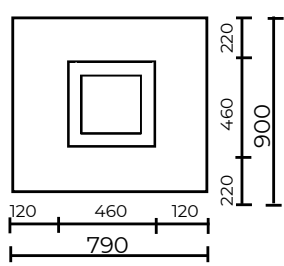

Minimum Cut Size
510mm x 510mm

460mm halves are on a triple half sheet

Westminster

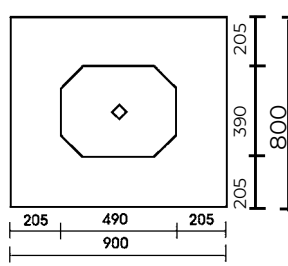

Minimum Cut Size
540mm x 440mm

**Please note - on Manor and
Manor inverted half panels
the grain runs vertically not
horizontally. These will be
supplied as standard unless
clearly specified otherwise.**

Flat Panels

Size	Available Woodgrain	Available Colourgrain
1500mm x 3000mm	No	No
900mm x 2100mm	Yes	Yes
900mm x 1040mm	Yes	No
440mm x 2100mm	Yes	No
440mm x 1040mm	Yes	No

Please Note - On grained flat panels the grain runs vertically
Woodgrains and Colourgrains are sold with 4mm MDF reinforcing as standard

Woodgrain Door Panels

All woodgrain and colourgrain panels feature 'heat-reflective' technology - an advanced technical process designed to significantly reduce the effect of UV light on darker surfaces thereby improving stability.

Hurst Doors have also introduced a system of venting the moulds which allows the expanding air to escape, thus reducing the incidence of de-lamination and cracking.

An adhesive is also used which has a higher co-efficient of expansion, greater elasticity properties and better adhesion qualities. Due to the nature of this product we strongly recommend that woodgrain door panels are not exposed to strong sunlight.

MDF and Thickness Options

	CM1 - Full Poly	CM3 - 4mm MDF	CM8 - MDF/ Poly/ MDF	CM10 - Poly/ Metal/ Poly	CM15 - Poly/ MDF/ Poly/ MDF/ Poly	CM16 - Solid MDF	CM17 - 8mm MDF	CM18 - 12mm MDF	CM20 - Poly/ Ali/ MDF/ Poly	CM21 - MDF/ MDF/ Ali
3000mm x 1500mm	20mm 24mm 28mm	20mm 24mm 28mm	24mm 28mm	20mm 24mm 28mm			24mm 28mm	28mm	20mm 24mm 28mm	28mm
900mm x 2100mm	20mm 24mm 28mm 18mm	20mm 24mm 28mm 19mm	24mm 28mm	20mm 24mm 28mm (Not on Colours)	28mm	20mm 24mm 28mm	20mm 24mm 28mm	24mm 28mm	20mm 24mm 28mm	28mm
900mm x 1040mm	24mm 28mm	24mm 28mm	24mm 28mm	24mm 28mm	24mm 28mm	24mm 28mm	24mm 28mm	24mm 28mm	24mm 28mm	
440mm x 2100mm	24mm 28mm	24mm 28mm	24mm 28mm	24mm 28mm	24mm 28mm	24mm 28mm	24mm 28mm	24mm 28mm	24mm 28mm	
440mm x 1040mm	24mm 28mm	24mm 28mm	24mm 28mm	24mm 28mm	24mm 28mm	24mm 28mm	24mm 28mm	24mm 28mm	24mm 28mm	

Ali is 0.6mm

Ancillaries

	Gold	Chrome	Black	Satin Chrome	White
Letterbox	Yes	Yes	Yes	Yes	Yes
Urn Knocker	Yes	Yes	Yes	Yes	Yes
Slimline Urn Knocker	Yes	Yes	Yes		Yes
Urn Knocker with Spyhole	Yes	Yes	Yes	Yes	Yes
Slimline Urn Knocker with Spyhole	Yes	Yes	Yes		Yes
Spyhole	Yes	Yes	Yes	Yes	Yes
Lion's Head Knocker	Yes		Yes		Yes
Numerals	Yes	Yes	Yes	Yes	Yes

Backing Glass Options

Platinum units must be reinforced

Clear	Chinchilla
Stippolyte	Florielle
Autumn	K Glass*
Everglade	Laminate*
Flemish	Mayflower
Sycamore	Oak
Contour	Pelerine
Cotswold	Sandblasted*/Satin*
Minster	Taffeta
Arctic	Warwick*
Chantilly	Satin*
Charcoal Sticks	Bronze Anti Sun*

* Surcharge applies

Colourgrain/ Woodgrain Options

Colourgrain	RAL	Available on Moulded Panels	Available on Flat Panels
Red	3011	Yes	Yes
Blue	5011	Yes	Yes
Chartwell Green		Yes	Yes
Green	6009	Yes	Yes
Silver Grey	7001	Yes	Yes
Slate Grey	7015	Yes	Yes
Anthracite Grey Grained	7016	Yes	Yes
Agate Grey	7038	No	Yes
Black/Brown	8022	Yes	Yes
Beige	9001	Yes	Yes
Cream/White	9010	Yes	Yes
White	9152	No	Yes
Irish Oak		Yes	Yes
An Teak		Yes	Yes

Woodgrain	Available on Moulded Panels	Available on Flat Panels
Rosewood	Yes	Yes
Mahogany - 013	Yes	Yes
Mahogany - 021	Yes	Yes
Golden Oak	Yes	Yes

Profile Options

Profile Name	White Code	Mahogany Code
Advance/Elite 70	626	
Decurnick	830	021
Decurnick Zendow	626	
Duraflex	625	013
Duraflex Warm	626	
Duraflex Bright	993	
Eurocell	830	013
Kommerling	626	021
Legend 70	C154	013
Linier	830	013
Profile 22	626	013
Rehau	626	021
Selecta	626	013
Spectus	2152	013
Synseal Synergy/Sheild	689	013
Synseal Legend	C154	013
System 10	626	013
Veka	2152	021
WHS Halo	626	021
Hurst Standard	623	

Stock Backing Glass

PANELS	CLEAR	AUTUMN	CONTOUR	COTSWOLD	MINSTER	STIPPOLYTE	ARCTIC	CHANTILLY	CHARCOAL	CHINCHILLA	EVERGLADE	FLEMSIH	FLORIELLE	K GLASS	LAMINATE	MAYFLOWER	OAK	PELERINE	S/BLAST	SYCAMORE	TAFFETA	WARWICK	
ALNWICK 1																							
ALTHORPE 1 INVERTED																							
BALMORAL 1																							
BALMORAL 1 CLASSIC																							
BALMORAL 1 CLASSIC SIDE																							
BALMORAL SLIMLINE 1																							
BALMORAL 2																							
BLENHEIM 1																							
BRUGES 1 SIDE																							
BRUGES 4 SIDE																							
CAMBRIDGE 1																							
CANTERBURY 1																							
CANTERBURY 1 SIDE																							
CANTON 1																							
CHATSWORTH 1																							
HAMBURG 1																							
KENSINGTON 1 SIDE																							
KENSINGTON 2																							
KENSINGTON 2 INVERTED																							
KENSINGTON 2 SIDE																							
KENSINGTON 4																							
LYON 1																							
MADRID 1 SIDE																							
MADRID 2																							
MALAGA 5																							
OVAL 1																							
OXFORD 1																							
REIMS 1 SIDE																							
RICHMOND 1																							
ROCKINGHAM 1																							
ROME 1																							
SANDRINGHAM 1																							
SANDRINGHAM 1 SIDE																							
SANDRINGHAM 2 SIDE																							
SANDRINGHAM 3																							
SANDRINGHAM 3 SIDE																							
SANDRINGHAM 5																							
SEVILLE 1																							
TURIN 1																							
WINDSOR 2 INVERTED																							
WINDSOR 2 SIDE INVERTED																							
WINDSOR 3 SIDE INVERTED																							
WINDSOR 4 INVERTED																							
WINDSOR 6 INVERTED																							
WINDSOR 1 SIDE																							
WINDSOR 2																							
WINDSOR 2 SIDE																							
WINDSOR 3 SIDE																							
WINDSOR 4																							
WINDSOR 6																							
5013 MODERN PANEL																							
5034 MODERN PANEL																							
5042 MODERN PANEL																							
5065 MODERN PANEL																							
5071 MODERN PANEL																							
5082 MODERN PANEL																							
5101 MODERN PANEL																							
5113 MODERN PANEL																							
5123 MODERN PANEL																							
5131 MODERN PANEL																							

Key

	Stock glass
	Non-stock glass (generally available in standard lead times,
	Unavailable glass

Class Sizes

Panel Type	Projection	C/B	Actual size mm		Sightline mm		
			Width	Height	Width	Height	
Acacia One Inverted		No	252	548	217	555	
Alnwick One		Yes	390	693	350	655	
Alnwick One Inverted		Yes	397	702	370	673	
Althorpe One Inverted		No	440	830	410	800	
Althorpe Oval One Inverted		No	325	585	310	570	
Balmoral One - small aperture		Yes	315	705	285	675	Top
Balmoral Two		Yes	315	315	285	285	Bottom
Balmoral One Classic - large aperture		Yes	445	840	410	805	Top
Balmoral Two Classic		Yes	445	445	410	410	Bottom
Balmoral Slim - Wendland 1		Yes	360	640	330	610	Top
Balmoral Slim - Wendland 2		Yes	360	360	325	325	Bottom
Balmoral One Classic Side		Yes	185	845	150	805	Top
Balmoral Two Classic Side		Yes	185	440	150	400	Bottom
Blenheim		No	420	420	390	390	
Cambridge Georgian Bow Fronted	33mm	N/A	500	770	100	190	
Canterbury One		Y + Arch	437	1180	400	1135	1 sheet glass
Canterbury One Side		Not advised	130	1175	95	1140	
Canton One		Yes	295	295	270	270	
Chatsworth		Yes	290	375	260	338	
Cheltenham		Yes	385	895	345	840	
Hamburg			295	295	265	265	
Harewood One		No	445	445	395	390	
Highgrove One		No	405	760	365	625	Top * See drawings tab
Highgrove Two		No	403	466	365	420	Bottom * See drawings tab
Highgrove One Side		No	105	1385	65	1134	
Kensington Two		Yes	135	770	110	740/710	
Kensington Two Inverted		No	140	765	115	730/705	
Kensington Four		Yes	135	465	110	438	
Kensington One Side		Not advised	140	790	112	755	Top
Kensington Two Side		Not advised	135	465	110	438	Bottom
Madrid Two		Not advised	130	1175	95	1140	
Madrid One Side		Not advised	130	1175	95	1140	
Malaga Five		No	130	1175	95	90	x 5
Oxford One		Yes	445	707	405	610	
Richmond One		No	421	837	370	785	
Rockingham One		Yes	375	885	345	840	
Rome One		No	180	1485	135	1425	
Sandringham One		Yes	440	178	385	107	
Sandringham Three		Yes	135	465	110	438	x2
Sandringham Five		Yes	135	465	110	438	x4
Sandringham One Side		No	140	700	110	144	Top
Sandringham Two Side		No	135	465	110	438	Bottom
Sandringham Three Side		No	135	465	110	438	Bottom
Seville		N/A	502	985			1 sheet glass (usually)
Sofia One		No	200	1160	155	1110	
Turin One			295	295	340	340	
Turin Two			162	1039	120	910	
Versailles			420	975	165	230	
Versailles Side			175	925	135	245	
Windsor Two		Not advised	140	140	110	110	Top
Windsor Four		Not advised	135	465	110	438	Bottom
Windsor Six		Not advised	135	465	110	438	Bottom
Windsor One Side		Not advised	140	140	110	110	Top
Windsor Two Side		Not advised	135	465	110	438	Bottom
Windsor Three Side		Not advised	135	465	110	438	Bottom
5034			170	170	144	144	
5101			180	1485	155	1460	
5013			315	315	290	290	
5071			420	420	390	390	
5131			295	295	266	266	
5141			350	487	304	430	
5123 top			295	295	270	270	
5123 middle			175	175	144	144	
5123 bottom			140	140	114	114	
5113			175	175	144	144	
5051			300	1450	275	1420	
5082			130	1175	104	1150	
5162			345	590	295	530	

Terms & Conditions

1. General

1.1 All goods supplied by Hurst Plastics Limited of Unit 1, Kingston International Business Park, Somerden Road, Hedon Road, Hull, HU9 5PE (hereinafter referred to as "the Company") to any other party (hereinafter referred to as "the Customer") are sold subject to the following Terms and Conditions.

1.2 These terms and conditions exclude and override any other terms and conditions inconsistent herewith which the Customer might seek to impose, even though such other terms and conditions may be submitted in a later document or purport to exclude or supersede any terms and conditions inconsistent with them or may be contained in any offer acceptance or counter-offer made by the Customer.

1.3 No addition or variation of or exclusion of such terms and conditions, whether express or implied, shall be binding upon the Company unless accepted specifically in writing by a Director of the Company.

1.4 The Company's employees or agents are not authorised to make any representations unless confirmed by a Director of the Company in writing and in entering into the contract the Customer acknowledges that he has not relied on any representation which is not so confirmed.

2. Quotations and Prices

2.1 Quotations which comprise an invitation to treat may be withdrawn at any time.

2.2 All quotations for non-standard items must be in writing if to be relied upon.

2.3 Prices quoted in or acknowledgement of orders placed are strictly exclusive of Value Added Tax or other sales taxes which will in all cases be charged at the rate applicable at the date of despatch of goods.

2.4 The Company reserves the right to increase its prices without notice. Any price increase will be notified to the Customer as soon as it is reasonably possible.

3. Delivery and Risk

3.1 Delivery of any goods shall be made by the Customer collecting the goods at the Company's premises at any time after the Company has notified the Customer that the goods are ready for collection or if some other place for delivery is agreed by the Company for delivering goods to that place.

3.2 The Company will use all reasonable endeavours to deliver goods at the time specified in the contract but any date or time specified for delivery of performance is (unless agreed otherwise by a Director of the Company in writing) an estimate only and late delivery or performance shall not entitle the Customer to reject any goods or services, terminate the contract, withhold any payment, claim damages or any other remedies.

3.3 On receipt, goods should be checked with the advice note enclosed with the goods to ensure that there are no defects, that they are the goods ordered and to ensure the colour supplied is correct. Claims for defects, shortages, goods damaged in transit and incorrect delivery of the goods will only be considered if the Company (and where it is alleged that the goods have been damaged in transit, the carrier and the Company) receives written confirmation of the claim within 72 hours of delivery. Goods received damaged or in an unsatisfactory condition must be signed for as such on the carrier's delivery note. Subject to the provisions regarding warranties set forth herein, returns will not be accepted if the goods are incorrectly supplied or defective or the colour is wrong once they have been fitted, altered or modified in any way. The Company shall only be liable for the replacement value of the damaged or defective goods and shall under no circumstances be liable for any consequential loss to the Customer. If goods are purchased via the Internet, they can be returned by the customer within the seven day cancellation period specified in Clause 6.4. If goods are retained by the Customer after this period, then in all other respects the provisions of this Clause 3.3 apply.

3.4 In all cases where it is claimed that the goods supplied are damaged or defective pursuant to Clause 3.3 above the following procedure shall apply (provided that if the Customer does not notify the Company or permit it to investigate the claim in accordance with the terms of this Clause 3, the Customer shall not be entitled to reject the goods or claim damages or any other remedy and the Company shall have no liability for such defect, failure or damaged goods):

(a) For all orders placed or delivered outside the UK notification of any defect (including any warranty claim pursuant to Clause 9 hereof) or damage to goods shall constitute an order for further goods corresponding to the quality and type of those goods alleged to be damaged or defective and shall be invoiced for by the Company in the normal manner and paid for by the Customer in accordance with these terms and conditions. A representative of the Company shall attend at the Customer's premises within 3 months of such notification to verify that the goods are damaged or defective and upon doing so a credit note shall be issued to the customer for the value of damaged or defective goods. The Company may thereafter at its discretion arrange for the goods to be removed from the Customer's premises.

(b) For all orders placed and delivered within the UK, provided the Customer notifies the Company of its wish to do so within 72 hours of delivery of the goods, it may opt to follow the procedure outlined in sub clause (a) above. In the event that it does not do so or does not do so within the time scale set forth in the said sub-clause (a), the Customer shall arrange with the Company for the return of the goods to the Company's premises and upon receipt of the goods the Company shall inspect and shall issue a credit note for any or all of such goods which it shall in its discretion confirm as damaged or defective.

(c) If a Customer making an order via the Internet has grounds for belief that the goods are damaged or defective pursuant to Clause 3.3, then the Customer must notify the Company within seven days of receipt of the goods that the goods are damaged or defective. In all other respects, the provisions of Clauses 3.4 (a) and (b) will apply.

3.5 It is the objective of the Company to deliver goods within 10 days of the Customer placing an order. If goods have not been received by the Customer by the tenth day then it is the responsibility of the Customer to inform the Company of non-delivery. If the Company has not been informed of non-delivery within 24 hours following the tenth day then the Company will have no liability with regard to the alleged non-delivery of goods.

3.6 If proof of delivery is required by the Customer it must be requested as soon as is reasonably possible and not later than seven days before payment of the account is due. All export duties, taxes, levies etc. present or future in all countries with regard to the goods will be payable by the Customer.

3.7 The Company will provide insurance for the carriage of the goods. The goods will be insured with a company based in the UK. The amount to be insured will be not less than 2% of the invoice amount. Goods shall be at the risk of the Customer.

3.7.1 In the case of goods to be delivered at the Company's premises at the time when the Company notifies the Customer that the goods are available for collection; or

3.7.2 In the case of goods to be delivered otherwise than at the Company's premises at the time of the actual delivery of the said goods.

4. Payment

4.1 All accounts are payable in accordance with any Company quotation documents. If no terms are mentioned in the quotation documents, payment in full is due on the first day of the calendar month following the date of invoice to the Customer by the Company. The Company reserves the right to charge a fee for the processing of Customer payments made by credit card or debit card. The Company reserves the right to charge interest on overdue accounts at 2 per cent per month of the full invoice amount for the period from the date payment is due until the actual date of payment.

4.2 Payment for all goods will be made in pounds sterling unless otherwise agreed by the Company in writing.

4.3 The Company reserves the right at any time at its discretion to demand security for, or vary the terms and method of payment before continuing with or delivering goods in satisfaction of any order notwithstanding any subsisting agreement to provide credit to the Customer.

4.4 If the Customer fails to make any payment on the due date then without prejudice to any other right or remedy available to the Company, the Company shall be entitled to:

4.4.1 Cancel any subsisting supply contract with or suspend any further deliveries or collections by the Customer.

4.4.2 Appropriate any payment by the Customer to such goods (or goods supplied under any contract between the Customer and the Company) as the Company may think fit notwithstanding any purported appropriation by the Customer.

4.4.3 Refuse to deal with any claim under any warranty given by the Company under the contract pursuant to which payment is overdue or any other contract between the Company and the Customer whenever made and refuse to deal with any matter raised or outstanding under Clause 3.4 hereof.

4.4.4 Issue proceedings to recover monies due on the overdue account together with any other monies payable on any other orders placed by the Customer whether payment is due or not.

4.4.5 Any sums payable by the Company to the Customer on any account may at any time be offset by the Company against any sums payable by the Customer to the Company.

5. Goods Wrongly Ordered

Only with the written agreement of the Company will the return of goods wrongly ordered be accepted. Where goods have been specially made, altered or cut, they will not be accepted for return. In the event of the Company agreeing the return of goods as aforesaid the Company reserves the right to make a charge to the Customer in respect thereof, including with respect to the carriage thereof.

6. Cancellation

6.1 The Customer's order will be processed immediately by the Company and the production of goods undertaken.

6.2 The Company reserves the right to charge the Customer a reasonable fee should an amendment of or cancellation of an order for goods be communicated in writing to the Company any later than four hours after placement of the order.

6.3 Goods ordered and then produced by the Company but not delivered, due to the suspension of the Customer's trading account, will be charged in full to the Customer.

6.4 If a Customer has ordered the goods via the Internet, the Customer has the right to cancel their order within seven days of receipt of the goods. If the Customer chooses to do this, then they will receive a full refund for the goods once the goods have been returned to the Company.

7. Customer's Credit Standing

Quotations are given and orders accepted subject to the Company's approval of the account. Thereafter if, at its discretion, the Company ceases to be satisfied with the credit standing of the Customer, then the Company may at any time refuse to fulfil or process an order for goods in whole or in part and shall not be liable in damages or otherwise in respect of the said refusal.

8. Property and Retention of Title

8.1 The Customer is licensed by the Company to use or to agree to sell goods delivered to the Customer subject to the express condition that the entire proceeds of any sale or insurance proceeds received in respect of such goods are held in Trust for the Company and are not mixed with other moneys or paid into an overdraft bank account and shall at all times, be identifiable as the Company's money.

8.2 Notwithstanding delivery and the passing of risk in goods, title in goods supplied by the Company shall not pass to the Customer until all money due to the Company from the Customer, under any contract outstanding between the Company and the Customer, has been paid in full.

8.3 All goods shall, subject to Clause 8.1 hereof, be kept separate and distinct from all other property owned by the Customer and by third parties, shall be kept properly insured and in good and substantial repair and condition and be stored in such a way as to be clearly identifiable as belonging to the Company and the Customer will not allow any interference with any identification marks or serial number of goods.

8.4 The Company (without prejudice to its other rights or remedies) shall have the right to recover and sell goods until such time as title in goods has passed to the Customer and the Customer hereby grants to the Company its agents or employees an irrevocable licence to enter onto any premises where goods are stored for that purpose and in each such instance the Customer shall indemnify the Company in respect of the costs and expenses incurred by the Company in so doing.

8.5 Without prejudice to any other rights contained herein, the Company may at any time revoke the power of sale and use contained in Clause 8.1 hereof by notice to the Customer, if the Customer is in default for longer than 7 days in the payment of any sum whatsoever due to the Company, whether in respect of specific goods or any other goods supplied at any time by it to the Customer or if the Company has bona fide doubts as to the solvency of the Customer.

8.6 If goods are incorporated in or become a constituent of any other goods, the Company shall be given the ownership of those new goods as security of payment of all sums owing by the Customer to the Company. In the event of a sale of goods on their own or incorporated in other goods, the Company's beneficial entitlement shall attach to the proceeds of sale or to the claim for such proceeds.

9. Warranty

9.1 Subject to the conditions set out below the Company warrants that:

9.1.1 For goods purchased by the Customer which are installed in Europe north of the 45th latitude the colour change shall not be greater than 5 units on the yellow index scale after 10 years from date of the despatch of the product. For goods purchased by the Customer which are installed in Europe south of the 45th latitude the colour change shall not be greater than 5 units on the yellow index scale after 5 years from date of the despatch of the product. The above limit of colour change also applies to Vacuum formed sheets provided a colour change of no greater than 2 units on the yellow index scale occurred through the vacuum forming process. Any colour changes are to be measured against the relevant samples and standard of the manufacturer of such products.

9.1.2 For wood grained and colour grained products the goods purchased shall be free from bubbling and delamination, for goods purchased by the Customer which are installed north of the 45th latitude for a period of 5 years and for goods purchased by the Customer which are installed south of the 45th latitude for a period of 5 years.

9.1.3 Due to the manufacturing method of, and naturally occurring flaws in several of the glass ranges offered, minor imperfections, seeds, flaws, bubbles or similar may be evident but are deemed to be acceptable and no liability will be accepted by the Company. Similarly, certain glass ranges, essentially, but not exclusively, the triple glazed options, may be liable to 'crazing' or similar and no liability will be accepted by the Company.

9.1.4 The 'lead' strip utilised in certain glass unit designs may be subject to oxidation when exposed to the elements. As oxidation is a naturally occurring effect, it is not considered as a fault or flaw and the Company will accept no liability.

9.2 The above warranty is given by the Company subject to the following conditions and to the provisions of Clause 3 hereof generally:

9.2.1 The Company shall be under no liability in respect of any defect arising from any drawing, design, or specification supplied by the Customer;

9.2.2 Any typographical, clerical or other error or omission in any sales literature, quotation, price list, acknowledgement of order, invoice or other document or information issued by the Company shall be subject to correction without any liability on the part of the Company;

9.2.3 All dimensions, diagrams, images, colours and prices featured in any of the Company's printed or electronic material are to be considered correct and accurate at the time of going to press and no liability will be accepted by the Company for error or change howsoever caused;

9.2.4 The Company shall be under no liability in respect of any defect arising from fair wear and tear, willful damage, negligence, abnormal working conditions, failure to follow the Company's instructions (whether oral or in writing) misuse or alteration or repair without the Company's approval;

9.2.5 The Company shall be under no liability under the above warranty (or any other warranty, condition or guarantee) if it is not permitted such facilities for inspection, testing and repairs as may be reasonably requested by the Company pursuant to Clause 3 hereof;

9.2.6 The above warranty does not extend to materials not manufactured by the Company, in respect of which the Customer shall only be entitled to the benefit of any such warranty or guarantee as is given by the manufacturer to the Company, and with respect to the Company, which the Company is able to pass on to the Customer.

10. Trademarks, Patents and other Industrial Rights

10.1 If any claim is made against the Customer alleging that the goods or the service infringe any patent rights, registered designs, copyright or other industrial property rights of another then :-

10.1.1 The Customer shall forthwith notify the Company with full particulars; and

10.1.2 The Company or its suppliers or licensors (as the case may be) shall be at liberty at their expense to conduct all negotiations and/or litigation in respect thereof and (if necessary) in the name of the Customer; and

10.1.3 Except pursuant to a final award, the Customer shall not pay or accept any such claim or company proceedings without the consent of the Company (which shall not be unreasonably withheld or delayed); and if as a result of such negotiations or litigation the Customer shall be unable to use the goods substantially for the purpose for which they were intended then the Company shall refund them back and refund the price thereof and such refund shall be in full satisfaction of all claims by the Customer against the Company.

10.2 The Customer shall indemnify the Company against all actions, costs (including cost of defending legal proceedings), claims, proceedings and demands in respect of any infringement by the Company of patent rights, registered design, copyright, design rights or other industrial rights attributed to the Company complying with any special instructions from or requirements of the Customer relating to the goods or the service.

10.3 The Customer shall not represent to its customers that it sells products manufactured by the Company after the Customer shall have ceased to purchase such products on a regular basis from the Company and in such event the Customer shall return to the Company all sales literature relating to products manufactured by the Company.

11. Exclusions and Limitations

11.1 Subject as expressly provided in these Terms and Conditions and except where goods are sold to a person dealing as a consumer (within the meaning of the Unfair Contract Terms Act 1977) all warranties, conditions or other terms implied by statute or common law are excluded to the fullest extent permitted by law.

11.2 Any claim by the Customer arising other than pursuant to Clause 3 hereof shall be notified to the Company within a reasonable time after discovery of the defect or failure.

11.3 Where the Company is satisfied that the Customer has a valid claim under the warranties set forth out in Clause 9 hereof after the same has been duly notified to the Company the Company shall be entitled to replace the goods (or any part in question) free of charge or at the Customer's sole discretion refund to the Customer the price of the goods.

11.4 The Company shall not be liable for any consequential or indirect loss suffered by the Customer whether this loss arises from a breach of duty in contract or tort or otherwise. Non-exhaustive illustrations of consequential or indirect loss would be loss of profits, loss of contract, damage to property and personal injury (but only insofar as such injury is not caused by the Company's negligence).

11.5 Where goods are sold under a consumer transaction (as defined by the Consumer Transactions (Restrictions on Statements) Order, 1976) the statutory rights of the Customer are not affected by these Terms and Conditions.

12. Force Majeure

12.1 The Company will not be liable to the Customer or be deemed to be in breach of the contract by reason of any delay in performing or any failure to perform, any of the Company's obligations in relation to the goods, if the delay or failure was due to any cause beyond the Company's reasonable control. Without limiting the foregoing, the following will be regarded as causes beyond the Company's reasonable control;

12.1.1 act of god, explosion, flood, pest, fire or accident;

12.1.2 war or threat of war, sabotage, insurrection, civil disturbance or requisition;

12.1.3 acts, restrictions, regulations, bye-laws, prohibitions or measures of any kind on the part of any governmental, parliamentary or local authority;

12.1.4 import or export regulations or embargoes;

12.1.5 strikes, lock-outs or other industrial actions or trade disputes (whether involving employees of the Company or of a third party);

12.1.6 difficulties in obtaining raw materials, labour, fuel, part of machinery;

12.1.7 power failure or breakdown in machinery.

13. Indemnity

If goods are to be manufactured or any process is to be applied to goods by the Company in accordance with the specification submitted by the Customer, the Customer shall indemnify the Company against all loss, damages, costs and expenses awarded against or incurred by the Company in connection with or paid or agreed to be paid by the Company in settlement of any claim for infringement of any patent, copyright, design, trade mark or other industrial or intellectual property rights of any third party which results from the Company's use of the Customer's specification.

14. Termination

14.1 If the Customer commits a material breach of these terms, and (if such a breach is remediable) fails to remedy that breach within 30 days of the Customer being notified of the breach, then the Company may terminate the contract with immediate effect.

14.2 If the Customer makes any voluntary arrangement with its creditors or becomes subject to an administration order or (being a body corporate) goes into liquidation or (being a non corporate body) becomes bankrupt or an encumbrancer takes possession or a receiver is appointed of any of the assets of the Customer or the Customer ceases or threatens to cease to carry on business or the Company reasonably apprehends that any of the events mentioned above is about to occur then (without prejudice to any other right or remedy of the Company) the Company shall be entitled to cancel the contract or suspend any further delivery performance under the contract without any liability to the Customer and if goods have been supplied but not paid for the price shall become immediately due and payable.

15. Miscellaneous

15.1 No waiver by the Company of any breach of contract by the Customer shall be considered as a waiver of any subsequent breach of the same or any other provision.

15.2 Any notice to be given by either party to the other shall be in writing by pre-paid first class post or facsimile addressed to the other party at its registered office or principal place of business or such other address as may have been notified to such other party.

15.3 The contract will be subject to English Law and will be treated as having been made within England. As such, the parties agree to be bound by the non-exclusive jurisdiction of the English courts. However, we retain the right to serve proceedings in another jurisdiction of our choosing.

15.4 Due to the nature of materials used and the method of manufacture, we recommend that you allow for a tolerance of + or - 2mm to either the cut size or thickness of every infill panel.

15.5 No forbearance, indulgence or relaxation on the part of the Company shown or granted to the Customer in respect of any of the provisions of these Terms and Conditions will in any way affect, diminish, restrict or prejudice the rights or powers of the Company or operate as or be deemed to be a waiver of any breach by the Customer of the Terms and Conditions of the contract.

15.6 If any provision of the contract is held by a court or other competent authority to be invalid or unenforceable in whole or in part the validity of the other provisions of the contract and the remainder of the provision in question will not be affected.

16. Contracts (Rights of Third Parties) Act 1999

These terms are made for the benefit of the parties to it, and are not intended to be enforceable by anyone else except the parties' successors and valid assigns.



Enquiries:

Call 01482 790790

info@hurstdoors.co.uk

@HurstDoors

Visit hurstdoors.co.uk

Hurst Doors,
Unit One,
Kingston International Business Park,
Somerden Road, Hedon Road,
Hull HU9 5PE

Designs represented in this publication are protected by copyright owned by or licensed exclusively by Hurst Doors (Hurst Plastics Limited). Product Descriptions, Colours and Unique Features: Every effort is made to ensure that the products we supply correspond as closely as possible to the examples shown in the brochure. Due to a continuous development programme, Hurst Doors (Hurst Plastics Limited) reserve the right to alter specifications without prior notice. All specifications are correct at the time of going to print. E. & O. E.